



WOODWORKING

Wood-Mizer **TOOLS**



Las cuchillas de perfil Wood-Mizer son la mejor opción para cada operación de cepillado / moldeado. Nuestra oferta comienza con cuchillas de perfil estándar de 4 mm de espesor producidas en acero de calidad HSS 6% y se extiende a HSS 18%, HM u otras dimensiones personalizadas.

Toda la gama de herramientas de corte sobresale de los productos de la competencia, ya que se diseñan cuidadosamente en un software dedicado y se fabrican en el proceso de electroerosión (mecanizado por descarga eléctrica). Como resultado, el cliente obtiene una cuchilla perfilada con ángulos de corte calculados con precisión, que no requiere ningún rectificado final y mantiene siempre los parámetros de trabajo constantes.

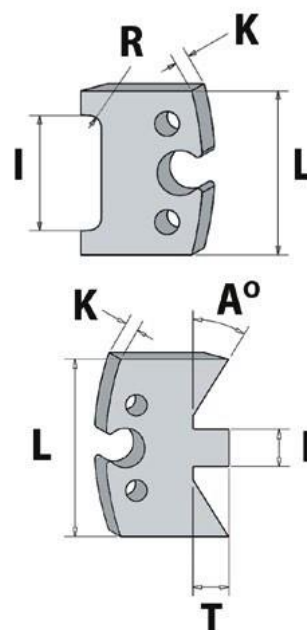

Explicación del número de artículo:

Productos que comienzan con
 TPPK94xxx - L = 40 mm de ancho, xxx = número particular de cuchilla de perfil
 TPPK95xxx - L = 50 mm de ancho, xxx = número particular de cuchilla de perfil
 TPPK96xxx - L = 60 mm de ancho, xxx = número particular de cuchilla de perfil
 TPPK910xx - L = 100 mm de ancho, xxx = número particular de cuchilla perfilada
 TPPK913xx - L = 130 mm de ancho, xxx = número particular de cuchilla perfilada

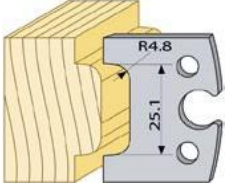
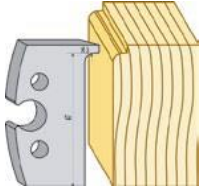
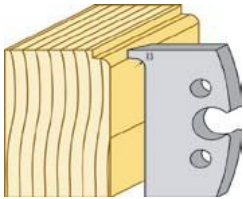
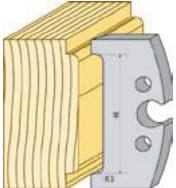
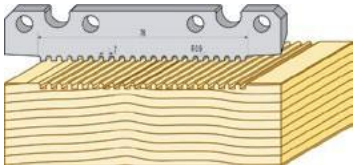
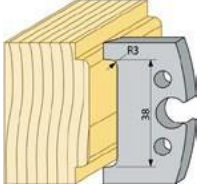

SUELOS Y CUBIERTAS CUCHILLAS

Referencia	Descripción	R (mm)	I (mm)	K (mm)	L (mm)	Imagen
TPPK94208HSS	Cuchilla para suelos y tarimas	3	22	4	40	
TPPK94248HSS	Cuchilla para suelos y tarimas	3	28	4	40	
TPPK94295HSS	Cuchilla para suelos y tarimas	3	25,4	4	40	
TPPK94275HSS	Cuchilla para suelos y tarimas	3	19	4	40	

Referencia	Descripcion	R (mm)	I (mm)	K (mm)	L (mm)	Imagen
TPPK94588HSS	Cuchilla para suelos y tarimas	4.8	25.1	4	40	
TPPK95006HSS	Cuchilla para suelos y tarimas	3	47	4	50	
TPPK95007HSS	Cuchilla para suelos y tarimas	3	46	4	50	
TPPK96017HSS	Cuchilla para suelos y tarimas	3	48	4	60	
TPPK91004HSS	Cuchilla para suelos y tarimas por arriba	0.9	78	4	100	
TPPK95047HSS	Cuchilla para suelos y tarimas	3	38	4	50	
TPPK95121HSS	Cuchilla para suelos y tarimas	3.2	38.1	4	50	

CUCHILLAS MACHIMBRADO HEMBRA Y MACHO

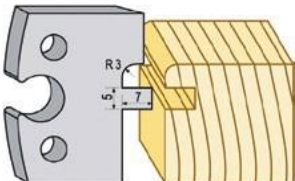
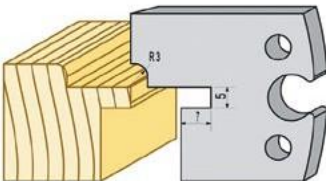
Referencia	Descripcion	R (mm)	T (mm)	I (mm)	K (mm)	L (mm)	Imagen
TPPK94205HSS	Cuchilla machimbrado hembra y macho	3	7	5	4	40	
TPPK94204HSS	Cuchilla machimbrado hembra y macho	3	7	5	4	40	

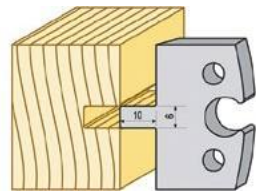
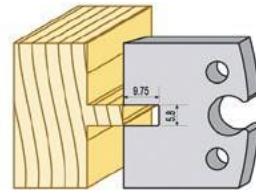
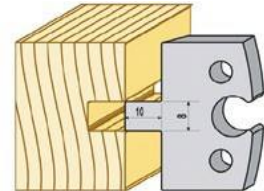
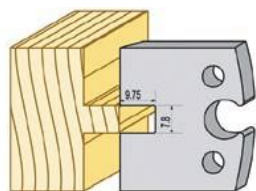
Referencia	Descripcion	T (mm)	I (mm)	K (mm)	L (mm)	Imagen
TPPK94324HSS	Cuchilla machimbrado hembra y macho	10	6	4	40	
TPPK94323HSS	Cuchilla machimbrado hembra y macho	9.75	5.8	4	40	
TPPK94326HSS	Cuchilla machimbrado hembra y macho	10	8	4	40	
TPPK94325HSS	Cuchilla machimbrado hembra y macho	9.75	7.8	4	40	

Referencia	Descripcion	T (mm)	I (mm)	K (mm)	L (mm)	Imagen
TPPK94328HSS	Cuchilla machimbrado hembra y macho	10	10	4	40	
TPPK94327HSS	Cuchilla machimbrado hembra y macho	10	10	4	40	

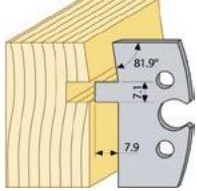
Referencia	Descripcion	A	T (mm)	I (mm)	K (mm)	L (mm)	Imagen
TPPK95125HSS	Cuchilla machimbrado hembra y macho	81.9°	7.9	7.1	4	50	

Referencia	Descripcion	T (mm)	T² (mm)	I (mm)	K (mm)	L (mm)	Imagen
TPPK95126HSS	Cuchilla machimbrado hembra y macho	7	6.4	6.4	4	50	

Referencia	Descripcion	A	T (mm)	I (mm)	K (mm)	L (mm)	Imagen
TPPK95005HSS	Cuchilla machimbrado hembra y macho	32°	10.2	10.4	4	50	
TPPK95004HSS	Cuchilla machimbrado hembra y macho	32°	9.8	10	4	50	

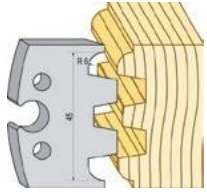
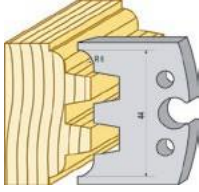
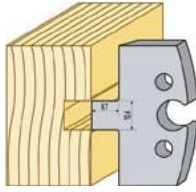
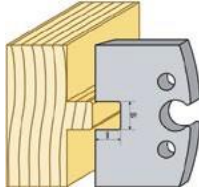
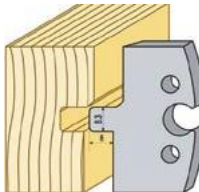
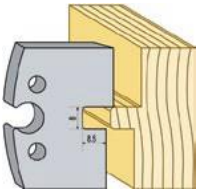
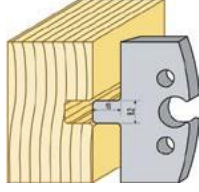
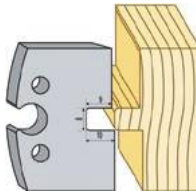
Referencia	Descripcion	T (mm)	I (mm)	K (mm)	L (mm)	Imagen	
TPPK95070HSS	Cuchilla machimbrado hembra y macho	6	45	4	50		
TPPK95071HSS	Cuchilla machimbrado hembra y macho	6	44	4	50		
TPPK95022HSS	Cuchilla machimbrado hembra y macho	9.7	10.4	4	50		
TPPK95021HSS	Cuchilla machimbrado hembra y macho	9	10	4	50		
TPPK95056HSS	Cuchilla machimbrado hembra y macho	8	8.3	4	50		
TPPK95057HSS	Cuchilla machimbrado hembra y macho	8.5	8	4	50		
TPPK95024HSS	Cuchilla machimbrado hembra y macho	10	8.2	4	50		
Referencia	Descripcion	T (mm)	T ₂ (mm)	I (mm)	K (mm)	L (mm)	Imagen
TPPK95023HSS	Cuchilla machimbrado hembra y macho	9	10	8	4	50	

CHAFLANES Y RADIOS

Referencia	Descripcion	A	I (mm)	K (mm)	L (mm)	Imagen
TPPK94216HSS	Cuchilla para chafanar	90°	26	4	40	
TPPK94282HSS	Cuchilla para chafanar	45°	5	4	40	
TPPK94265HSS	Cuchilla para chafanar	45°	17	4	40	
TPPK94343HSS	Cuchilla para chafanar	45°	20	4	40	
TPPK95029HSS	Cuchilla para chafanar	45°	32.2	4	50	
TPPK95015HSS	Cuchilla para chafanar	45°	38.6	4	50	
TPPK95016HSS	Cuchilla para chafanar	45°	27	4	50	

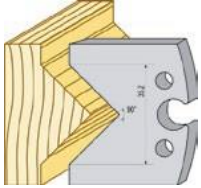
Referencia	Descripcion	A	I (mm)	K (mm)	L (mm)	Imagen
TPPK95052HSS	Cuchilla para chafanar	90°	35.2	4	50	

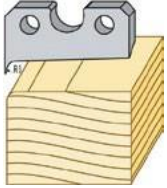
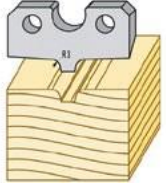
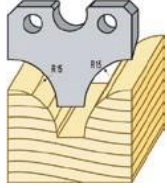
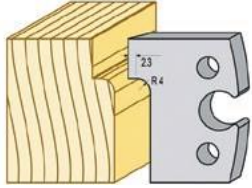
Referencia	Descripcion	R (mm)	K (mm)	L (mm)	Imagen
TPPK94223HSS	Cuchilla para radios	3	4	40	
TPPK94224HSS	Cuchilla para radios	3	4	40	
TPPK94297HSS	Cuchilla para radios	15	4	40	
TPPK94354HSS	Cuchilla para radios	4	4	40	

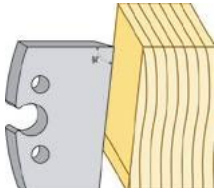
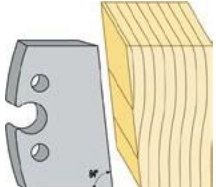
Referencia	Descripcion	A	K (mm)	L (mm)	Imagen
TPPK95027HSS	Cuchilla para chaflanar	84°	4	50	
TPPK95025HSS	Cuchilla para chaflanar	84°	4	50	

Referencia	Descripcion	A (mm)	K (mm)	L (mm)	Imagen
TPPK94298HSS	Cuchilla para chaflanar	135°	4	40	
TPPK94332HSS	Cuchilla para chaflanar	15°	4	40	

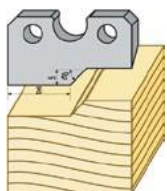
Referencia	Descripcion	T (mm)	A (mm)	I (mm)	K (mm)	L (mm)	Imagen
TPPK94280HSS	Cuchilla para chaflanar	20	45°	5	4	40	

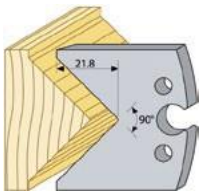
Referencia	Descripcion	A	T (mm)	K (mm)	L (mm)	Imagen
TPPK95032HSS	Cuchilla para chaflanar	90°	21.8	4	50	

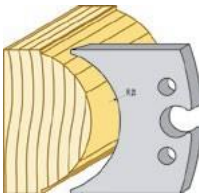
Referencia	Descripcion	T (mm)	R (mm)	K (mm)	L (mm)	Imagen
TPPK95054HSS	Cuchilla para radios	19	25	4	50	

Referencia	Descripcion	R (mm)	I (mm)	K (mm)	L (mm)	Imagen
TPPK94296HSS	Cuchilla para radios	4	30	4	40	

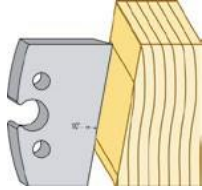
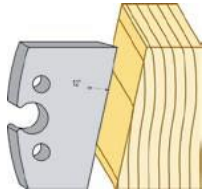
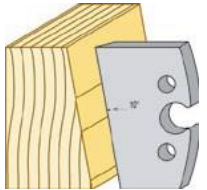
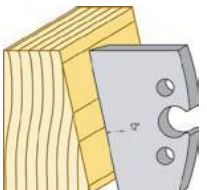
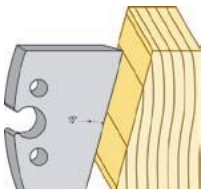
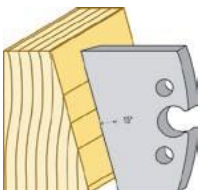
Referencia	Descripcion	A (mm)	K (mm)	L (mm)	Imagen
TPPK95058HSS	Cuchilla para chaflanar	15°	4	50	
TPPK95066HSS	Cuchilla para chaflanar	10°	4	50	
TPPK95062HSS	Cuchilla para chaflanar	12°	4	50	
TPPK95067HSS	Cuchilla para chaflanar	10°	4	50	
TPPK95063HSS	Cuchilla para chaflanar	12°	4	50	
TPPK95064HSS	Cuchilla para chaflanar	15°	4	50	
TPPK95065HSS	Cuchilla para chaflanar	15°	4	50	

PERFILES CONCAVOS

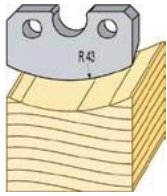
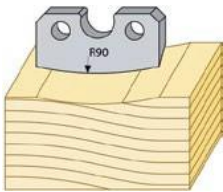
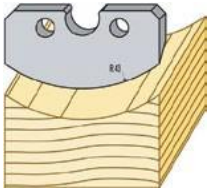
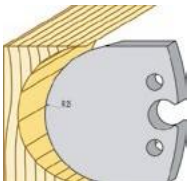
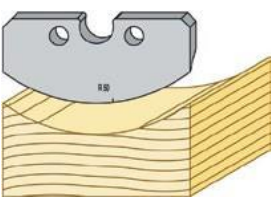
Referencia	Descripcion	R (mm)	K (mm)	L (mm)	Imagen
TPPK94217HSS	Cuchilla para concavos	43	4	40	
TPPK94218HSS	Cuchilla para concavos	90	4	40	
TPPK95010HSS	Cuchilla para concavos	43	4	40	
TPPK95053HSS	Cuchilla para concavos	25	4	50	
TPPK96005HSS	Cuchilla para concavos	50	4	60	

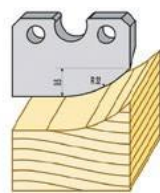
Referencia	Descripcion	R (mm)	T (mm)	K (mm)	L (mm)	Imagen
TPPK94260HSS	Cuchilla para concavos	32	9.5	4	40	

Referencia	Descripcion	R (mm)	I (mm)	K (mm)	L (mm)	Imagen
TPPK94256HSS	Cuchilla para concavos	8	12	4	40	
TPPK94257HSS	Cuchilla para concavos	8	12	4	40	

DECORACION

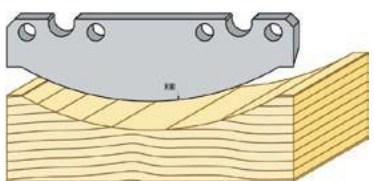
Referencia	Descripcion	R (mm)	I (mm)	K (mm)	L (mm)	Imagen
TPPK91003HSS	Cuchilla para decoracion	90	88	4	100	

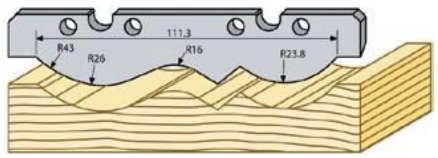
Referencia	Descripcion	I (mm)	K (mm)	L (mm)	Imagen
TPPK91301HSS	Cuchilla para decoracion	111.3	4	130	

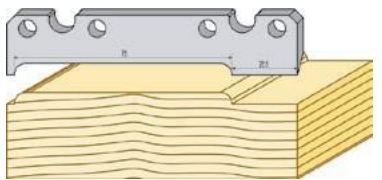
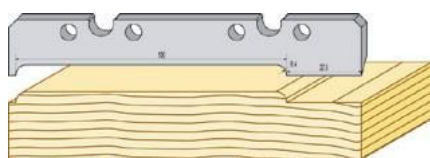
Referencia	Descripcion	R (mm)	I (mm)	I ¹ (mm)	K (mm)	L (mm)	Imagen
TPPK91014HSS	Cuchilla para decoracion	4	75	22.5	4	100	
TPPK91314HSS	Cuchilla para decoracion	4	100	27.5	4	130	

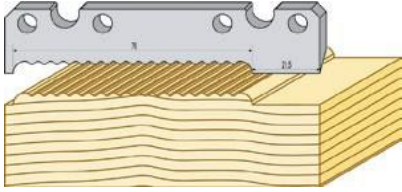
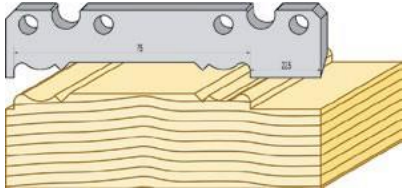
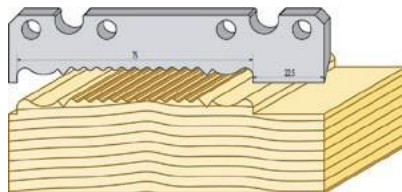
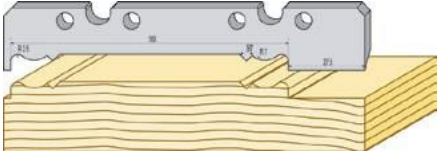
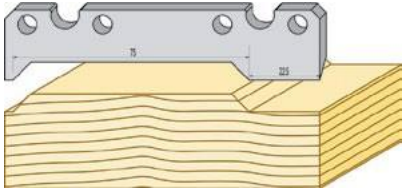
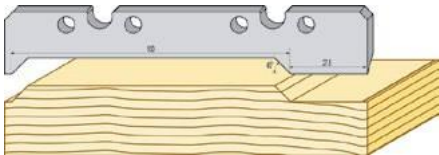
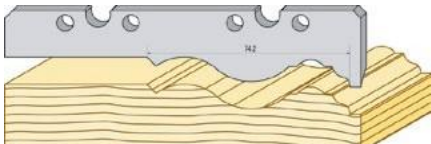
Referencia	Descripcion	I (mm)	I ¹ (mm)	K (mm)	L (mm)	Imagen
TPPK91015HSS	Cuchilla para decoracion	76	21.5	4	100	
TPPK91010HSS	Cuchilla para decoracion	75	22.5	4	100	
TPPK91011HSS	Cuchilla para decoracion	75	22.5	4	100	
TPPK91310HSS	Cuchilla para decoracion	100	27.5	4	130	
TPPK91012HSS	Cuchilla para decoracion	75	22.5	4	100	
TPPK913125HSS	Cuchilla para decoracion	100	27.5	4	130	
TPPK91321HSS	Cuchilla para decoracion	74.2	52.8	4	130	

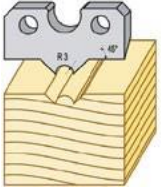
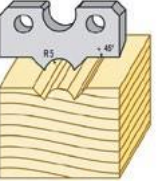
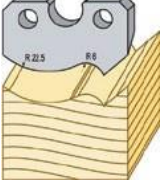
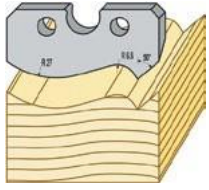
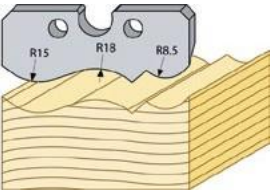
Referencia	Descripcion	R (mm)	A	K (mm)	L (mm)	Imagen
TPPK94345HSS	Cuchilla para decoracion	3	45°	4	40	
TPPK94361HSS	Cuchilla para decoracion	5	45°	4	40	
TPPK94215HSS	Cuchilla para decoracion	22.5 + 6	50°	4	40	
TPPK95014HSS	Cuchilla para decoracion	27 + 6.5	50°	4	50	
TPPK96007HSS	Cuchilla para decoracion	15 + 18 + 8.5	50°	4	60	

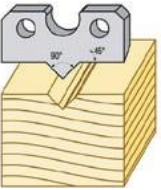
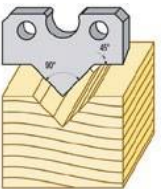
Referencia	Descripcion	A	A ¹	K (mm)	L (mm)	Imagen
TPPK94359HSS	Cuchilla para decoracion	90°	45°	4	40	
TPPK94360HSS	Cuchilla para	90°	45°	4	40	

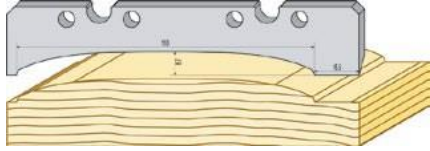
Referencia	Descripcion	I (mm)	I ¹ (mm)	T (mm)	K (mm)	L (mm)	Imagen
TPPK91318HSS	Cuchillas para decoracion	110	19.5	8.7	4	130	

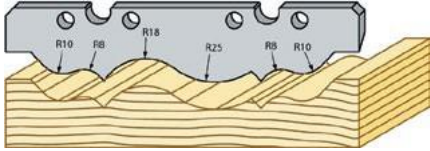
Referencia	Descripcion	I (mm)	T (mm)	K (mm)	L (mm)	Imagen
TPPK91320HSS	Cuchillas para decoracion	113.1	11.1	4	130	

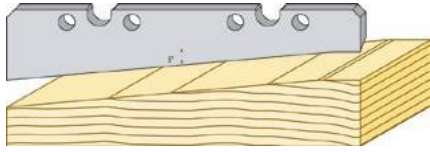
Referencia	Descripcion	A	I (mm)	K (mm)	L (mm)	Imagen
TPPK91323HSS	Cuchillas para decoracion	5°	119	4	130	

PERFILES TUBULARES

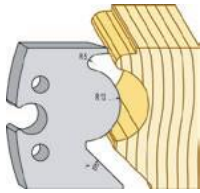
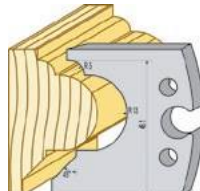
Referencia	Descripcion	R (mm)	A	I (mm)	K (mm)	L (mm)	Imagen
TPPK95039HSS	Cuchilla tubular	15 + 13	45°	46.1	4	50	
TPPK95038HSS	Cuchilla tubular	15 + 13	45°	46.1	4	50	

Referencia	Descripcion	R (mm)	I (mm)	K (mm)	L (mm)	Imagen
TPPK95031HSS	Cuchillas para decoracion	15 + 13	46.3	4	50	
TPPK95030HSS	Cuchillas para decoracion	15 + 13	46	4	50	
TPPK95049HSS	Cuchillas para decoracion	15 + 18.3	46	4	50	
TPPK95050HSS	Cuchillas para decoracion	15 + 18.3	46	4	50	

PERFILES DE RELIEVES

Referencia	Descripcion	A	T (mm)	I (mm)	K (mm)	L (mm)	Imagen
TPPK94261HSS	Cuchilla para relieves	45°	1.7	36.6	4	40	
TPPK96008HSS	Cuchilla para relieves	45°	1.7	56.6	4	60	

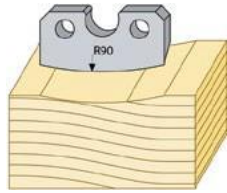
Referencia	Descripcion	R (mm)	K (mm)	L (mm)	Imagen
TPPK94218HSS	Cuchilla para relieves	90	4	40	

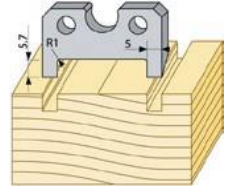
Referencia	Descripcion	R (mm)	T (mm)	I (mm)	K (mm)	L (mm)	Imagen
TPPK94219HSS	Cuchilla para relieves	1	5.7	5	4	40	

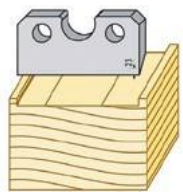
Referencia	Descripcion	R (mm)	I (mm)	K (mm)	L (mm)	Imagen
TPPK94229HSS	Cuchilla para relieves	2.3	40	4	40	

PERFILES TRASLAPADO TECHOS - TEJADOS

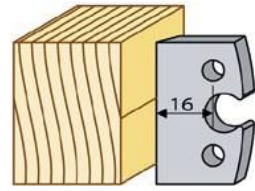
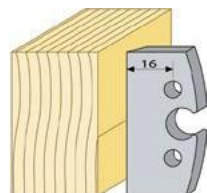
Referencia	Descripcion	I (mm)	K (mm)	L (mm)	Imagen
TPPK9000-16HSS	Cuchilla para traslapar techos y tejados	40	4	40	
TPPK9500-16HSS	Cuchilla para traslapar techos y tejados	50	4	50	

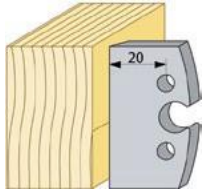
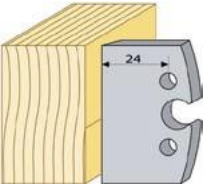
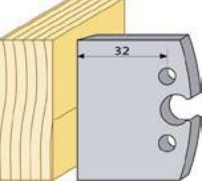
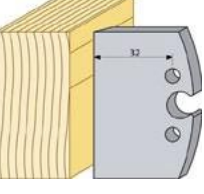
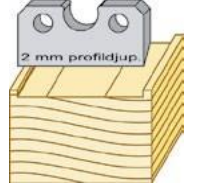
Referencia	Descripcion	T (mm)	I (mm)	K (mm)	L (mm)	Imagen
TPPK9500-20HSS	Cuchilla para traslapar techos y tejados	4	50	4	50	
TPPK9500-24HSS	Cuchilla para traslapar techos y tejados	8	50	4	50	
TPPK9500-32HSS	Cuchilla para traslapar techos y tejados	16	50	4	50	
TPPK9600-32HSS	Cuchilla para traslapar techos y tejados	16	60	4	60	
TPPK94232HSS	Cuchilla para traslapar techos y tejados	2	40	4	40	

Referencia	Descripcion	T (mm)	K (mm)	L (mm)	Imagen
TPPK94240HSS	Cuchilla para traslapar techos y tejados	10	4	40	

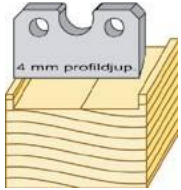
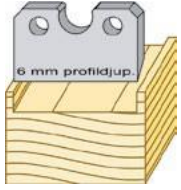
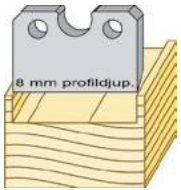
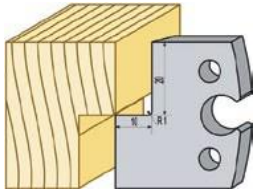
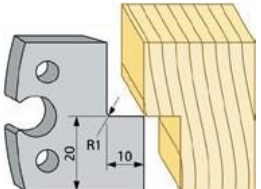
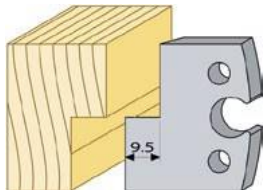
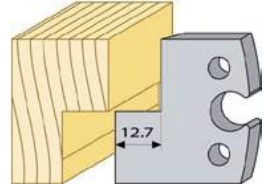
Referencia	Descripcion	T (mm)	I (mm)	K (mm)	L (mm)	Imagen
TPPK94234HSS	Cuchilla para traslapar techos y tejados	4	40	4	40	
TPPK94236HSS	Cuchilla para traslapar techos y tejados	6	40	4	40	
TPPK94238HSS	Cuchilla para traslapar techos y tejados	8	40	4	40	
TPPK94214HSS	Cuchilla para traslapar techos y tejados	10	20 + 20	4	40	
TPPK94244HSS	Cuchilla para traslapar techos y tejados	10	20 + 20	4	40	
TPPK94648HSS	Cuchilla para traslapar techos y tejados	9.5	20 + 20	4	40	
TPPK94647HSS	Cuchilla para traslapar techos y tejados	12.7	20 + 20	4	40	

Kit basico cuchillas MP260

Referencia: **TPPKMP260.WM**

Este paquete incluye 9 pares de cuchillas de perfil (40 mm) para producir revestimientos, paneles, traslapes y terrazas.

El juego de cuchillas básico MP260 viene con 3 pares de cuñas KIL-038.

Referencia	Descripcion	L (mm)	Par
TPPK94670HSS	Cuchilla machimbrado hembra y macho	40	1
TPPK94671HSS	Cuchilla machimbrado hembra y macho	40	1
TPPK94843HSS		40	1
TPPK94842HSS		40	1
TPPK94248HSS	Cuchilla para suelos y tarimas	40	2
TPPK94647HSS	Cuchilla para suelos y tarimas	40	2
TPPK94261HSS		40	1

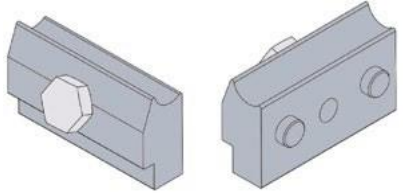
Referencia	Descripcion	Pares	Imagen
KIL-038	Cuñas	3	

PROFILE KNIVES



Ejemplos de utilizacion:

- Exterior y interior con traslapado. 12.7mm con ranura.

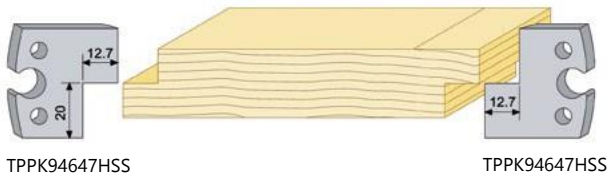

- Interior y exterior revestimientos y paneles, con junta en V, machimbrado.

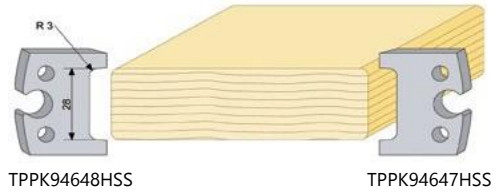

- Interior y exterior panelados. Manchimbrados.

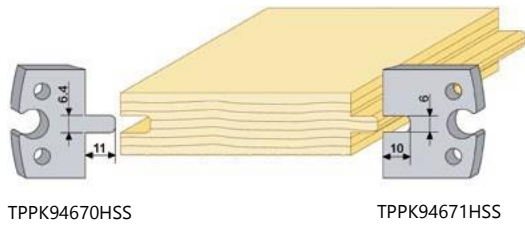

- Cuchilla rebaje posterior para revestimientos y paneles.

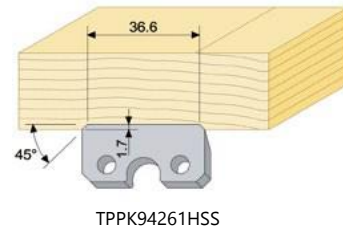

- Interior y exterior revestimientos y paneles Radio 4 Manchimbrado.

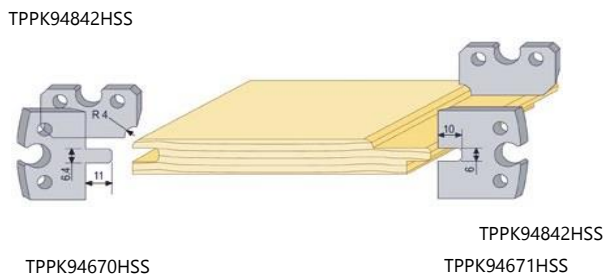

- Interior y exterior revestimientos y paneles, con junta en V, machimbrado

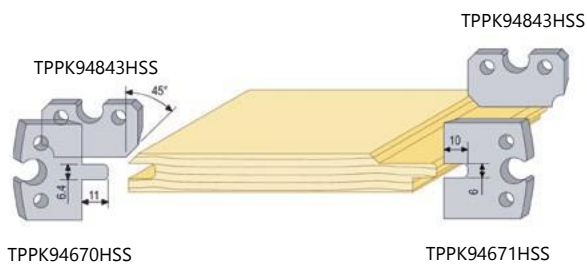

PROFILE KNIVES



Extension kit cuchillas MP260

Referencia: TPPKMP260EXT.WM

Este paquete incluye 11 pares de cuchillas perfiladoras (40 mm), 4 pares de cuchillas perfiladas (60 mm) para la producción de revestimientos, paneles, traslapes y terrazas. El juego extendido MP260 viene con 3 pares de cuñas KIL-038.

Referencia	Descripcion	L (mm)	Par
TPPK94670HSS	Cuchilla machimbrado hembra y macho	40	1
TPPK94671HSS	Cuchilla machimbrado hembra y macho	40	1
TPPK94843HSS		40	1
TPPK94842HSS		40	1
TPPK94647HSS		40	2
TPPK94261HSS		40	1
TPPK94277HSS		40	1
TPPK94276HSS		40	1
TPPK94219HSS		40	1
TPPK94361HSS		40	1
TPPK96097HSS		60	1
TPPK96098HSS		60	1
TPPK96099HSS		60	1
TPPK96100HSS		60	1

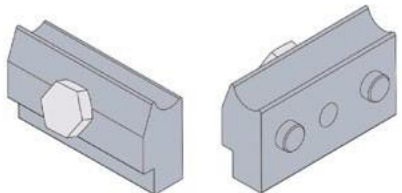
Referencia	Descripcion	Pares	Imagen
KIL-038	Cuñas	3	

Ejemplos de utilizacion:

- Interior y exterior revestimientos y paneles, con junta en V, machimbrado

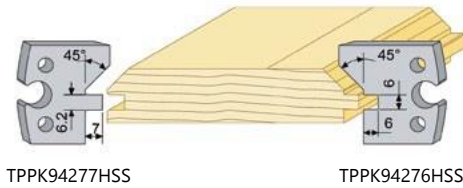

TPPK94277HSS

TPPK94276HSS

- Cuchilla rebaje posterior para revestimientos y paneles.

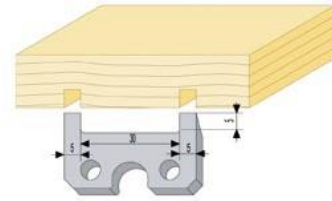

TPPK94219HSS

- Exterior y interior con traslapado. 12.7mm con ranura.

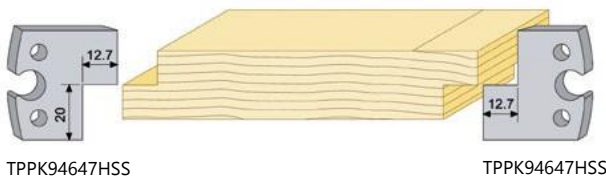

TPPK94647HSS

TPPK94647HSS

- Perfil redondo recortado en la parte superior.

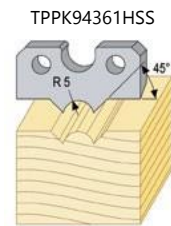

TPPK94361HSS

- Interior y exterior panelados. Manchimbrados.

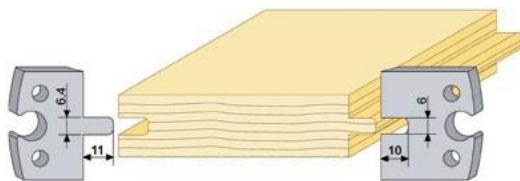

TPPK94670HSS

TPPK94671HSS

- Cuchilla rebaje posterior para revestimientos y paneles.

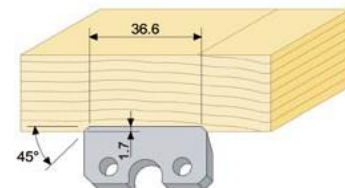

TPPK94261HSS

- Interior y exterior revestimientos y paneles Radio 4 Manchimbrado.

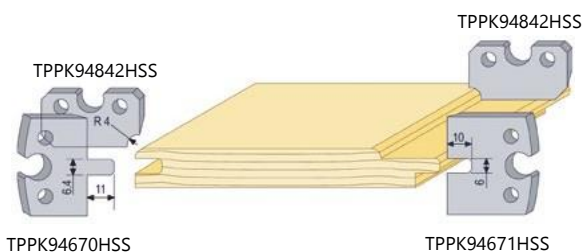

TPPK94842HSS

TPPK94842HSS

TPPK94670HSS

TPPK94671HSS

- Perfiles de Radio 4, espesor ajustable entre 13-51 mm.

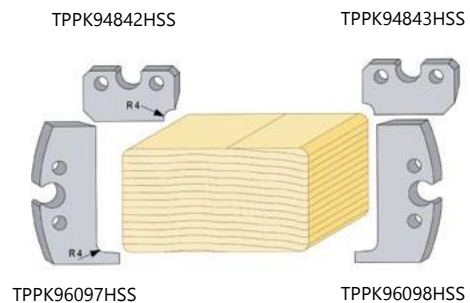

TPPK94842HSS

TPPK94843HSS

TPPK96097HSS

TPPK96098HSS

- Interior y exterior revestimientos y paneles, con junta en V, machimbrado

- Perfiles Junta - V 45, espesor ajustable entre 13-51 mm.

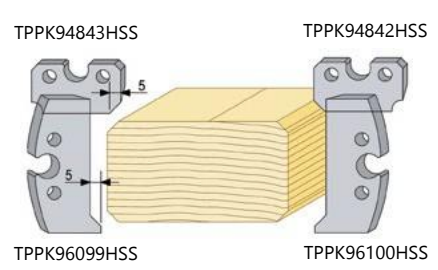
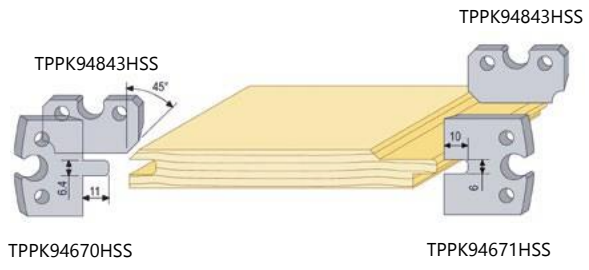

EUROPE • woodmizer.eu | AFRICA • woodmizerfrfrica.com | ASIA • woodmizerasia.com 

Kit Basico cuchillas MP360

Referencia: TPPKMP360.WM

Este paquete incluye 9 pares de cuchillas de perfil (40 mm) para producir revestimientos, paneles, traslapes y terrazas.

El juego básico MP360 viene con 2 pares de cuñas KIL360-038 y 1 par de cuñas KIL-038.

Referencia	Descripcion	L (mm)	Par
TPPK94670HSS	Cuchilla machimbrado hembra y macho	40	1
TPPK94671HSS	Cuchilla machimbrado hembra y macho	40	1
TPPK94843HSS		40	1
TPPK94842HSS		40	1
TPPK94248HSS	Cuchilla para suelos y tarimas	40	2
TPPK94647HSS	Cuchilla para suelos y tarimas	40	2
TPPK94261HSS		40	1

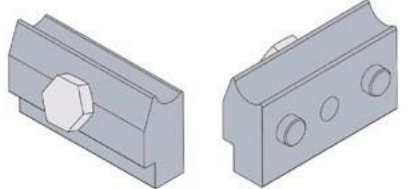
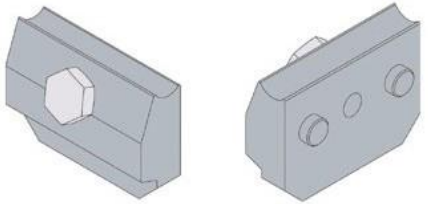
Referencia	Descripcion	Pares	Imagen
KIL-038	Cuña	1	
KIL360-038	Cuña	2	



Ejemplos de utilizacion:

- Exterior y interior con traslapado. 12.7mm con ranura.

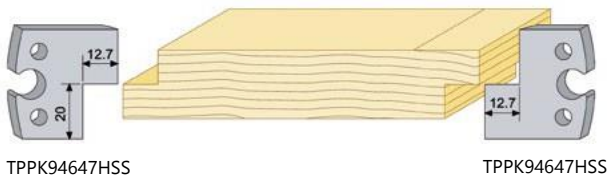

- Interior y exterior revestimientos y paneles, con junta en V, machimbrado.

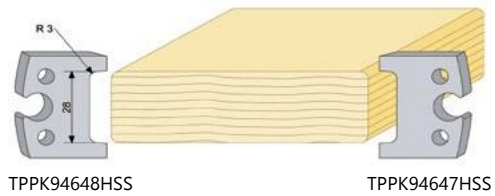

- Interior y exterior panelados. Manchimbrados.

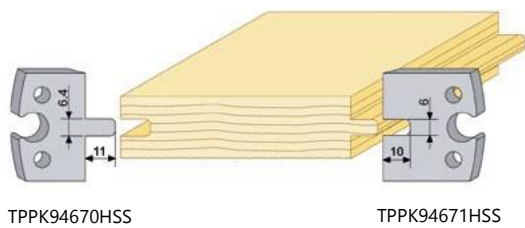

- Cuchilla rebaje posterior para revestimientos y paneles.

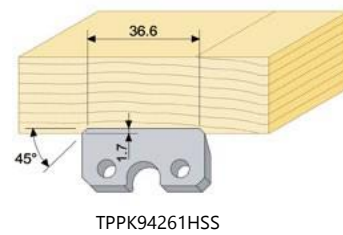

- Interior y exterior revestimientos y paneles Radio 4 Manchimbrado.

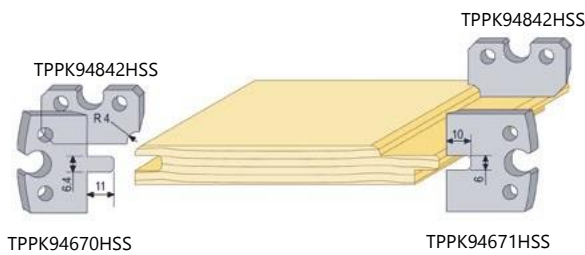

- Interior y exterior revestimientos y paneles. Juntas - V.Machimbrado.

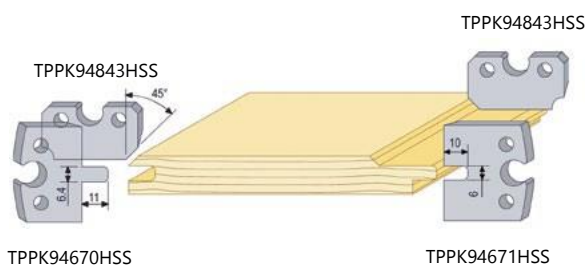

Extension set cuchillas MP360

Referencia: TPPKMP360EXT.WM

Este paquete incluye 11 pares de cuchillas perfiladoras (40 mm),
4 pares de cuchillas perfiladas (60 mm) para la producción de revestimientos, paneles,
traslapes, techos y terrazas.

El juego extendido MP360 viene con 3 pares de cuñas KIL360-038 más 1 par de cuñas KIL-038.

Referencia	Descripcion	L (mm)	Pairs
TPPK94670HSS	Cuchilla machimbrado hembra y macho	40	1
TPPK94671HSS	Cuchilla machimbrado hembra y macho	40	1
TPPK94843HSS		40	1
TPPK94842HSS		40	1
TPPK94647HSS		40	2
TPPK94261HSS		40	1
TPPK94277HSS		40	1
TPPK94276HSS		40	1
TPPK94219HSS		40	1
TPPK94361HSS		40	1
TPPK96097HSS		60	1
TPPK96098HSS		60	1
TPPK96099HSS		60	1
TPPK96100HSS		60	1

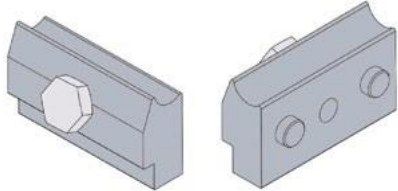
Referencia	Descripcion	Par	Imagen
KIL-038	Cuña	1	

KIL360-038

Cuña

3

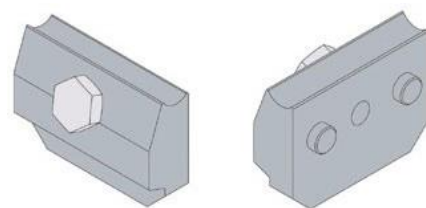

Ejemplos de utilizacion:

- Interior y exterior revestimientos y paneles. Juntas - V. Machimbrado.

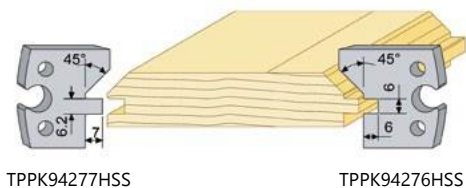

- Cuchilla rebaje posterior para revestimientos y paneles.

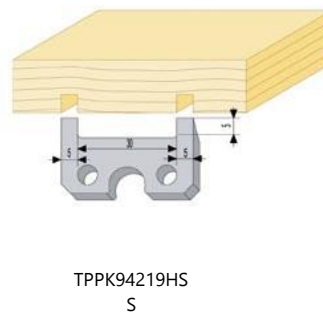

- Exterior y interior con traslapado. 12.7mm con ranura.

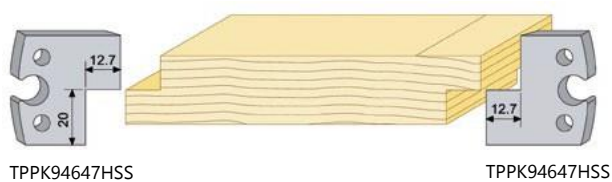

- Perfil redondo recortado en la parte superior.

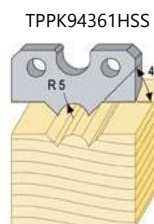

- Interior y exterior panelados. Manchimbrados.

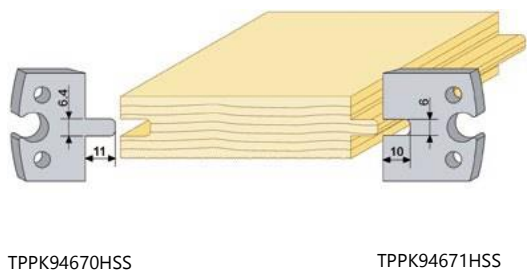

- Cuchilla rebaje posterior para revestimientos y paneles.

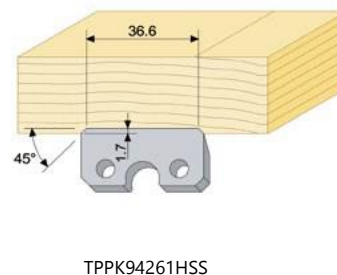

- Interior y exterior revestimientos y paneles. Juntas - V. Machimbrado.

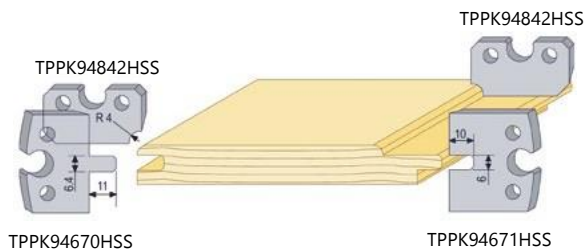

- Perfiles Junta – V45, espesor ajustable entre 13-51 mm.

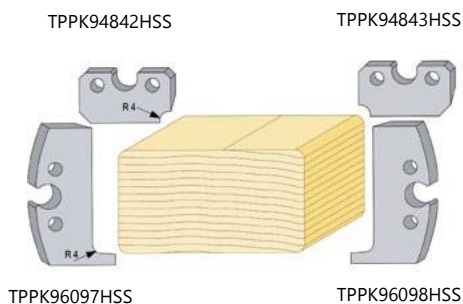

- Interior y exterior revestimientos y paneles
Juntas – V. Machimbrado.

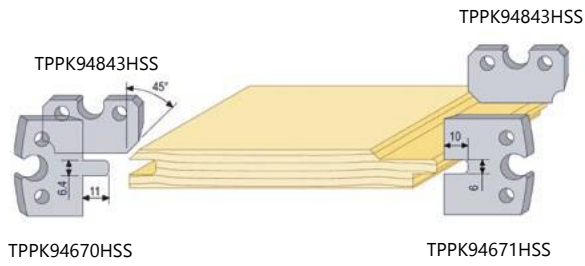

- Perfiles Junta – V45, espesor ajustable entre 13-51 mm.

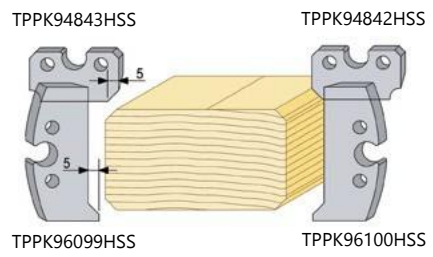

EUROPE • woodmizer.eu | AFRICA • woodmizerafrika.com | ASIA • woodmizer.com





Wood-Mizer Industries, Poland

Since 1982, Wood-Mizer has taken thin-kerf, narrow-band technology and production well beyond what anyone ever imagined possible. Because of the company's rich history of patents and innovative designs that challenge traditional thinking, Wood-Mizer is recognized as a worldwide leader in the forest industry.

Through a network of locations and dealers around the globe, Wood-Mizer provides solutions to customers that require everything from a single machine to complete systems to efficiently and profitably process wood

Desde 1982, Wood-Mizer ha llevado la tecnología y la producción de corte fino y hoja estrecha mucho más allá de lo que cualquiera hubiera imaginado posible. Debido a la rica historia de patentes y diseños innovadores de la empresa que desafían el pensamiento tradicional, Wood-Mizer es reconocido como líder mundial en la industria forestal..

A través de una red de ubicaciones y distribuidores en todo el mundo, Wood-Mizer brinda soluciones a los clientes que requieren todo, desde una sola máquina hasta sistemas completos para procesar la madera de manera eficiente y rentable.

Wood-Mizer®

Wood-Mizer Industries Sp. z o.o.

European Headquarters and Manufacturing

Facility Nagórna 114, 62-600 Koło, Poland

from forest to final form